

### Foreword

This manual relates to matters affecting the operation of the Type 28 AT dry gas seal within compressor machinery. It covers areas directly associated with the installation, removal, operation and maintenance of the gas seal. For other related subjects, such as the correct operation of associated systems or guidance when conducting hazard analysis (as may be required under the European ATEX Directives), consult with the compressor equipment supplier and their documentation.

The gas seals are robust in operation. However, any incorrect handling or assembly fitting can easily lead to seal damage. Therefore, John Crane's gas seals may only be installed, commissioned and maintained by a fully trained and authorised plant machinery specialist. This person must pay close attention to these instructions, the John Crane gas seal installation drawing, compressor equipment supplier's manuals and documentation and all relevant regulations. Failure to do this relieves the manufacturer John Crane from any liability or warranties. It is strongly recommended that the seals are fitted by John Crane trained and approved technicians.

Most often, a further seal type is situated between the gas seal and the compressor bearing chamber. The function of this seal is to prevent the ingress of bearing oil into the gas seal. This type of seal could be a labyrinth or some form of mechanical seal and can be known by several generic names such as tertiary seal, barrier seal or separation seal. Throughout this document, this seal will be referred to as the separation seal.

If there are any gas seal problems that need an urgent response, please contact your local John Crane sales representative..

### Safety

The safety notes refer to the gas seal arrangement supplied. They can never be exclusive, and must be used in conjunction with the relevant safety regulations for the machine, auxiliary equipment, plant and sealed fluid.

#### Warning symbols

The following symbols are used in this instruction manual to highlight information of particular importance



**Danger – Mandatory instructions designed to prevent injury or extensive damage.**

**ATTENTION** Special instructions and/or information to avoid damage to the seal and/or its surroundings.

**NOTE** Information for easy installation and efficient operation.



**Prior to any installation, removal, operation and maintenance of the gas seals, all personnel involved in these activities must have read and understood this document before the commencement of any work. If there is not adequate understanding, contact John Crane for further advice.**

**All personnel involved in the installation, operation and maintenance of the gas seal must have adequate training and understanding with regards to:**

- The gas seals being used
- The equipment being worked on, including any relevant auxiliary equipment and systems
- All tooling and equipment associated with fitting and removing seals
- The environment in which work is being carried out
- Health, safety and environmental issues associated with the above points including all relevant local site, national and international health, safety and environmental procedures and regulations.

**Any working practice that compromises safety must be avoided.**

**All personnel involved in the installation, removal, operation and maintenance of the separation seals must be authorized by the responsible party to work on the equipment that the gas seals are fitted to.**

**At all times, adequate personal protection equipment should be worn/used. This equipment needs to be suitable for the environment and surroundings that a person is working within.**

**At all stages in work relating to the gas seal, reference must be made to the John Crane installation drawing, this document and the compressor equipment supplier's manuals and documentation and all relevant regulations.**

**Gas seal cartridge disassembly is not required for normal operation and maintenance and must never be undertaken other than by a John Crane trained technician approved for the seal type being worked on. Where gas seals require inspection and refurbishment, please contact John Crane.**

**Modifications and/or alterations of the gas seal in any way are not permitted without the authority of John Crane. Failure to obtain this authority relieves the manufacturer John Crane from any liabilities or warranties.**

**In the event of an operating problem, the machinery must be immediately switched off and made safe. Problems must be solved promptly.**

**A small controlled gas flow (commonly called the gas seal leakage) will occur within the gas seal during normal seal operation. In cases of a worn or defective seals, the leakage volumes will increase. This leakage may be hazardous, toxic and or explosive.**

**Attention is also drawn to the fact that, on its own, gas seal leakage may not be dangerous. However, if it was to combine with other gases, liquids and/or substances with increased or decreased pressure and temperature or be subjected to heat and/or an ignition source, then the mixture may become hazardous, toxic and/or explosive.**



All leakage will need to be collected and directed to a safe location by the equipment and systems that the gas seals are fitted to. This needs to occur under all circumstances including when the gas seals ARE and ARE NOT working normally. It is the responsibility of the compressor/machine manufacturers and equipment operators to ensure that the systems and procedures are in place to accommodate this and that these systems provide adequate health and safety to all people, as well as protection for the environment.

In the rare case of catastrophic gas seal failure, a bulk escape of process gas and/or buffer gas within the compressor casing can occur past the gas seal. This leakage may be hazardous, toxic and/or explosive. It is the responsibility of the compressor/machine manufacturers and equipment operators to ensure that systems and procedures are in place to deal with this occurrence and that these systems provide adequate health and safety to all people, as well as protection for the environment.

Hot surfaces have to be protected against accidental contact.

Dry gas seals and separation seals can become exposed to extreme conditions, particularly during process upset and seal failure. Suitable personal protection equipment must be worn during handling removal and disassembly of previously used seals. This includes gloves, coveralls and footwear, as well as protective headgear appropriate to the location.

In addition, hazardous chemicals and dust can be present within the seals. A suitable FFP3 respirator is therefore recommended. (Apart from potentially unknown chemicals in the process fluids, if gross over-heating has occurred, hydrofluoric acid and other noxious compounds may be formed).

Follow the local relevant guidelines for the safe and environmentally friendly disposal of assembly lubricants, supplied fluids and scrapped components. Compounds containing PTFE, fluorocarbons and perfluoroelastomers should never be burned as the fumes and residues are highly toxic.

When returning seals to John Crane, customers MUST confirm in writing that the specific seals being returned are safe to handle and provide any additional safety-critical information on request. This is further discussed in Appendix II of this document.

### Seal Installation and Removal



Any lifting equipment used for the installation and extraction of the separation seals must be adequate for the situation and comply to all health and safety requirements.

**Any tooling used for the installation and extraction of the gas seals must be suitable for the duty it is being used for, in good condition and comply to all health and safety requirements.**

### Seal preparation

#### NOTE

Seal installation and extraction tools are not supplied by John Crane. Consult the compressor equipment supplier's manuals and documentation for any special tool requirement or recommendations. An assessment of required fitting tooling should be made prior to carrying out any installation or removal of the gas seals and this tooling should be made available.

#### ATTENTION

John Crane gas seals in purpose-designed transportation cases and wrapped within cellophane or sealed bags. On initial unpacking of the seal from the case:

1. Check packaging for visible signs of damage.
2. Check consignment is complete with all items being present when compared to the list of items provided within the case.
3. Open all packaging carefully. If sharp instruments such as knives or scissors are used, take care not to damage sealing elements such as O-rings.

If there are any issues, contact John Crane.

Prior to installation, the entire outer surface of the separation seal cartridge including the seal bore should be clean and dry.



**Do not fit the separation seal if the outside of the seal cartridge is significantly dirty, stained with hydrocarbon tar deposits or wetted with fluids as this may indicate the seal has been internally contaminated. In such an event contact John Crane.**

**Never clean the separation seal with cleaning fluids or solvents that could enter the cartridge and attack vulnerable components such as the O-rings or cause corrosion.**

#### ATTENTION

In the case of very minor dirt or fluid present on the outside of the separation seal cartridge that can be easily cleaned away and there is no risk of internal seal contamination, then it is possible to continue with seal installation. If in any doubt, contact John Crane.

All O-rings fitted to the outside diameter and in the bore of the cartridge should be carefully examined for damage such as cuts or crushing. If damaged, they should be replaced with a correct part from the spares/installation kit, in accordance with the installation drawing.

On certain gas seal designs, tolerance rings are located within the seal sleeve bore of the gas seal. Figure 1. The function of these tolerance rings is to centralise the seal rotor on the compressor shaft. If during service the tolerance rings have become damaged and crushed then they can be replaced as per the instructions of Appendix III.

**ATTENTION** Carefully check all external screws on the cartridge for any signs of looseness that may have occurred. If any have become loose, re-tighten using an appropriate Allen key. If in any doubt, contact John Crane before installing the gas seal.

### Compressor preparation



The compressor cavity into which the gas seal is fitted must be in accordance with the gas seal Installation drawing.

Prior to any work being carried out on the compressor, it must be in a safe condition. All pressures within the compressor casing need to be atmospheric pressure with no differential pressures present (including partial vacuum conditions). No hazardous or toxic gases or liquids must be present and any required decontamination procedures must be carried out. For further information, consult the compressor equipment supplier's manuals and documentation.

The compressor casing and shaft must be adequately earthed and electrical earth continuity must be maintained. See compressor equipment suppliers manual and documentation for details.

The following text assumes that the compressor has been made safe and that the required installation and extraction tools are available.

To provide lubrication between the compressor shaft and the gas seal rotor during installation, John Crane recommends the use of either:

- Dow Corning MolyKote® G-N Paste or MolyKote® G-N Plus Paste
- Jet-Lube White Knight™ anti-seize compound

The above individual substances should not be mixed and must be applied sparingly, and only at the seal bore/compressor shaft interface.

For any O-ring situated on the **outside diameter only** of the seal cartridge (outside diameter of the retainers of the seal stator), sparingly lubricate with a thin layer of silicone grease.

**ATTENTION** Under no circumstances must silicone grease be used for shaft/seal sleeve assembly lubrication otherwise shaft sleeve galling can occur.

Any excessive silicone grease and anti-seize compound must be removed, and care taken to prevent ingress of these lubricants into the dry gas seal during cartridge installation. Extra care should be taken when gas vent holes are present through the radial section of the seal rotor as this provides a direct path through to the internals of the seal. Figure 1.

The suitability of alternative lubricants should be confirmed with John Crane.

1. Clean the entire area within the compressor into which the gas seal fits. Ensure that it is free from defects and any rough or sharp edges and burrs that could damage the seal on installation.

### Installation, Operation & Maintenance Instructions

**FIGURE 1. Gas seal with installation plates fitted**

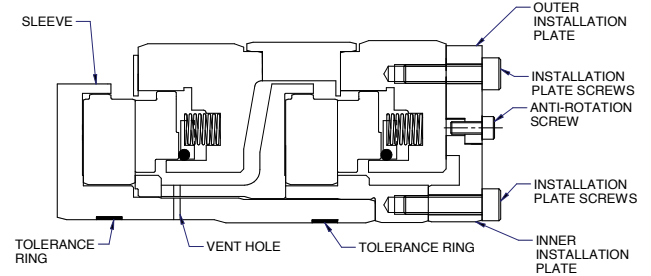

**FIGURE 1a. Tandem Gas Seal Cartridge**

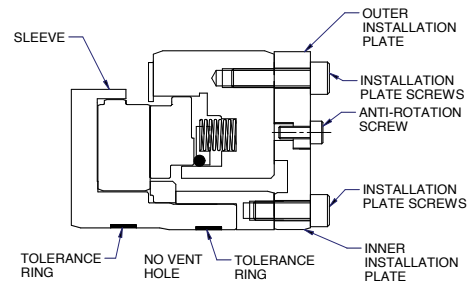

**FIGURE 1b. Single Gas Seal Cartridge**

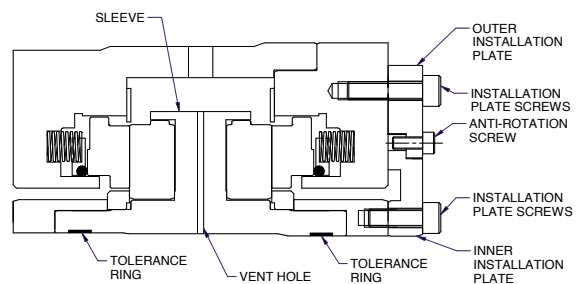

**FIGURE 1c. Double Gas Seal Cartridge**

2. Ensure that the compressor shaft is positioned correctly to the compressor casing to allow fitting of the gas seal. Both the axial and radial alignment needs to be considered. Ensure that the shaft is angularly aligned with the casing such that any pin positions, keys, bolts or other features in the shaft and casing are aligned with the corresponding features within the gas seal with the installation plates fitted (see seal installation drawing and Figure 1). Consult the compressor equipment supplier's manual and documentation for appropriate method for shaft and casing alignment.



**The compressor shaft should be locked to prevent it from moving whilst fitting the gas seal into position. For further information, consult the compressor equipment supplier's manuals and documentation.**

3. If the dry gas seals have not been previously fitted to the compressor or if there is a new rotor, check that the seal chamber is in accordance with the installation drawings.

4. Apply a thin film of anti-seize compound to the compressor shaft.
5. Axial positioning shims or spacers may be provided. If supplied, these need to be adjusted by appropriate machining to achieve the correct rotor to stator working position. Once correctly adjusted, fit shims or spacers into the compressor or to seal cartridge as shown on the installation drawing or compressor equipment suppliers manuals and documentation.

### Fitting the Gas Seals



**Ensure that the gas seal cartridge is the correct one for the compressor shaft end that it is being fitted to. Consult equipment supplier's manuals and documentation to ascertain correct part numbers and compare these against the seal cartridge part numbers and the seal installation drawings. The allowable direction of rotation for a gas seal cartridge is shown on the installation drawing and is also printed/etched onto the seal cartridge itself.**

1. Loosen all the screws of both the inner and outer installation plate fitted to the gas seal by one turn each only (see Figure 1). Do not loosen screws excessively.
2. Using appropriate lifting equipment carefully position the gas seal on to the shaft.
3. Align any key ways, pins, slots, holes or other features within the seal with corresponding features sited within the compressor casing and shaft. If there is minor angular misalignment between the compressor casing, compressor shaft and gas seal, remove any anti-rotation screw within the installation plates (Figure 1) and rotate the seal rotor until alignment is achieved. If misalignment is excessive see Compressor Preparation, number 2.
4. Using the fitting tools provided by the compressor manufacturer (or suitable studding and jacking bar), carefully and evenly jack the gas seal assembly into position by applying jacking force to the seal stator.



**While fitting the gas seal, it is imperative that it is kept square to the shaft axis in order to prevent it binding onto the shaft.**

5. When the gas seal is fully engaged home, remove all fitting tools.
6. Remove the seal installation plates and their screws as per the installation drawing.
7. Secure the seal stator into the compressor casing and the seal rotor to the shaft using the appropriate components as shown on the installation drawing or if not shown, then as per the compressor equipment supplier's manual and documentation.



**Any John Crane supplied screws used to retain seal components must be tightened adequately. Where these screws are secured into non John Crane supplied parts, then consult with the compressor equipment suppliers manuals and documentation for any bolt torque requirements.**

**Any separation seal parts should be fitted in accordance with the separation seal supplier's documentation.**

**It is essential that both the gas seal rotor and stator are located in the correct axial position as identified on the installation drawing. Any axial misalignment of the seal rotor to the stator will potentially result in seal failure.**

**It is essential that the gas seal rotor is effectively locked onto the compressor shaft and the seal retainer effectively locked within the compressor chamber and that any locking devices are fully secured and tightened. Please consult the compressor equipment suppliers manuals and documentation.**

**Prior to any attempt to rotate the shaft, the seal installation plates and associated screws must be removed.**

**Complete compressor assembly as per the compressor equipment supplier's manuals and documentation.**

**If compressor shaft has been locked, ensure this has been removed prior to any compressor operation. Consult compressor equipment supplier's manual and documentation for further information.**

### Removal of the Gas Seals



**Before removal of the gas seal, the compressor needs to be in a safe state. All pressures within the compressor casing need to be atmospheric pressure with no differential pressures present (including partial vacuum conditions). No hazardous or toxic gases or liquids must be present and any required decontamination procedures must be carried out. For further information, consult the compressor equipment supplier's manuals and documentation.**

In accordance with the compressor equipment supplier's instructions, disassemble the compressor to the point where there is access to the gas seal.



**The compressor shaft should be locked to prevent it from moving whilst removing the gas seal from the compressor. For further information, consult the compressor equipment supplier's manuals and documentation.**

1. Carefully study the installation drawing. All devices that secure the gas seal stator or rotor to the compressor casing or shaft must be removed.



# TYPE 28 AT

## GAS SEAL

- Fit the seal installation plates as identified on the installation drawing. It is not necessary to fit the anti-rotation screw (see Figure 1).
- Fit the removal tools as provided by the compressor manufacturer (or suitable studding and jacking bar) to facilitate gas seal removal.
- Fit any required lifting equipment.
- Using these tools, extract the gas seal cartridge from the compressor housing by applying a jacking force to the seal stator.
- Using lifting equipment, remove the seal cartridge from the shaft.



**It is imperative that while extracting the gas seal cartridge, that the cartridge is kept square to the shaft axis in order to prevent it binding onto the shaft. If the gas seal is removed without the appropriate installation plates, severe damage may occur to the seal cartridge or the compressor shaft and cavity.**

### Commissioning Procedure



**Once the gas seals have been installed into the compressor and prior to commissioning of the gas seals, all commissioning procedures as required by the compressor equipment supplier must be carried out and the compressor must be in a safe condition before any pressure is applied to the compressor or the compressor shaft is rotated or the compressor is operated. For further information, consult the compressor equipment supplier's manuals and documentation.**

**The following text assumes that the compressor is in a safe condition in accordance with the above and that any required procedures have been carried out.**

### Static Gas Seal Test

This task should be undertaken following gas seal cartridge installation and prior to starting the compressor.

- With the equipment drive coupling disconnected, it is recommended where possible to rotate the compressor shaft to ensure freedom of movement.
- If a separation seal is installed, commission the separation seal gas system and ensure that it is functioning correctly. This must be done prior to any bearing lubrication oil operation/circulation.
- Pressurise the compressor casing incrementally up to line pressure. Record the gas seal primary stage leakage rate against each pressure increment.
- If leakage is observed that is close to or greater than alarm settings, the compressor must be depressurised and the cause of the high leakage rectified.

### Dynamic Operation

- Commence normal start up procedure as defined by the compressor equipment supplier's manual and documentation. Periodically record the gas seal primary stage seal leakage rate during the first 4 hours of operation or until full compressor operating conditions are reached dependent on which is longer.

### Installation, Operation & Maintenance Instructions

- If excessive leakage is observed i.e. close to or greater than alarm settings, then the compressor must be shut down and depressurised and the cause of the high leakage rectified..

### Compressor Operation and Maintenance

The gas seals are designed to cover the widest range of operating parameters and require virtually no maintenance. The gas seal should be continuously monitored (especially gas consumption and leakage) and data recorded using the compressor logging system. A trend of changing leakage, temperature, vibration or other parameters being monitored at or around the gas seal may give forewarning of a seal problem.



#### OPERATING AND ENVIRONMENTAL CONDITIONS

**The gas seal must not be subjected to operating conditions, environmental conditions, substances and fluids outside those defined by the contract of gas seal supply, the installation drawing and this document.**

#### REVERSE ROTATION

The direction of rotation for the gas seal is shown on the installation drawing. It is also printed/etched on to the gas seal cartridge. It must be ensured that gas seals are fitted for the correct direction of compressor shaft rotation.

Reverse rotation is only permissible on bi-directional designs of gas seals.

Uni-directional gas seals are not designed to operate with reverse rotation and this must be avoided as damage will most likely be incurred that will lead to future seal failure. If the seals are subjected to any form of reverse rotation no matter how brief the duration, then contact John Crane. In almost all circumstances, the seals will require inspection by a John Crane trained and approved technician and replacement before further operation.

#### REVERSE PRESSURE

**Reverse pressure occurs when down stream pressure is greater than upstream pressure acting on an individual gas seal sealing stage. The seals are not designed to operate with reverse pressure.**

**If it occurs under static conditions (i.e. compressor shaft is not rotating and is at standstill), reverse pressure will result in that sealing stage opening and not sealing the reverse pressure. For many compressor systems, flare gas will be unclean, highly contaminated and contain liquids. In these instances, if reverse pressure were encountered with flare pressure then the gas seal itself would be contaminated resulting in loss of performance and the risk of failure. Reverse pressure with contaminated flare gas is not acceptable.**

**If reverse pressure occurs on a sealing stage under static conditions with very clean flare gas (cleanliness being within the limits for normal gas seal operations) or buffer gas, then the gas seal will open and not seal this pressure. Under these conditions there is a risk that**



internal O-rings can be dislodged from their correct working position such that once pressure is restored to the correct direction it may not be sealed. If reverse pressure occurs under these circumstances then it is required that with the pressure differential restored to the correct direction, a static pressure test is carried out to assess correct seal performance. This must be done before any dynamic operation of equipment.

Under dynamic operation, any reverse pressure will result in damage that will in almost all circumstances lead to catastrophic failure and therefore must be avoided.

### MINIMUM SEAL SPEED

For any dynamic operation, the rotor speed must exceed the minimum speed as defined within the contract of gas seal supply. This covers all types of compressor operation including compressor testing, field operation and any maintenance operation. Failure to comply may lead to damage that could lead to seal failure. It is particularly important that gas seals are in a clean condition and free from contamination for slow speed operation.

### TRIP AND ALARM VALUES

For optimum seal life, seals should be operated within the conditions as defined within the contract of gas seal supply. Compressor maintenance and satisfactory monitoring of operation parameters should be carried out to ensure this is the case and where performance trends are exceeding these conditions, corrective actions should be implemented prior to reaching alarm conditions. Examples of where this is good practice relates to parameters such as seal gas leakage, buffer gas consumption, gas cleanliness and compressor vibration.

If during operation an alarm value is encountered then this should be investigated and the cause rectified immediately. The seals should not operate continuously above alarm values. Seals must not be operated above any of the set trip values for compressor performance.

### SEAL LEAKAGE

John Crane provides seal leakage values upon which the compressor supplier will define the alarm and trip values. These values are significantly higher than expected leakage values quoted by John Crane. If seal leakage approaches and or reaches the alarm value, then investigations need to be carried out into why leakage is so high and preparations should be made for seal replacement as soon as possible. Seals should not operate continuously above the alarm value. Seals must not be operated above the trip leakage value. If this condition is reached then the compressor should be shut down and made safe immediately.



### CONTAMINATION

By far the largest cause of seal failure during service is contamination. While very small quantities of hydrocarbon condensate and/or oil on the sealing surfaces are generally not detrimental to gas seal operation, the general ingress of these substances into the seal must be avoided to permit good sealing performance and long life. The greater the degree of contamination, the greater the risk of seal failure. The two primary sources for contamination are dirty process gas or bearing lubrication oil entering the seal. If it is suspected that quantities of hydrocarbon condensate, oil or any form of debris has contaminated the seal, compressor operations needs to stop, the cause rectified and the gas seal replaced. Contaminated gas seals should only be inspected by a John Crane trained and approved technicians. Contaminated gas seals should be returned to John Crane for cleaning and refurbishment. Contaminated gas seals should not be operated.

To help prevent contamination, it should be ensured that the clean gas injection that buffers process gas from the seal is:

- Always of adequate quantity and quality
- Always at least 20°C/68°F above the dew point. This includes gas leakage that passes across the seal face that is subject to adiabatic expansion and the Joule Thomson effect
- Always applied before process gas is applied and is present during all forms of operation including both static and dynamic operation
- Only turned off once all process gas has passed through the compressor

The separation seal buffer gas must always be applied before the bearing lubrication oil starts to circulate and only be turned off after the bearing lubrication system is turned off.

Filters for all dry gas seal supplies should be coalescing type and have a minimum efficiency of 99.9% for particles less than or equal to 1µm (39µin) - beta ratio  $\beta_1 \geq 1000$ . Where required, gas conditioning systems should be employed to ensure clean gas supply and the removal of any liquids. Seal performance issues relating to contamination of any kind will not be covered by the seal warranty. John Crane can advise further on contamination issues and gas conditioning as required.

### HIGH STATIC PRESSURE HOLDS

Dependent on the process and clean buffer injection gas, there is the risk of the formation of condensation, liquid drop out and possible freezing at the seal faces under high pressure static operating conditions (i.e. no significant shaft rotation). This is due to the cooling that occurs with adiabatic expansion and the Joule Thomson



effect when gas flows for a length of time from high pressure to low pressure at high speed across the seal faces or under labyrinths. This can lead to further seal problems.

**On applications where this can occur, precautions need to be taken to prevent this either by ensuring adequate gas temperature is maintained under all conditions or by reducing the static pressure such that the cooling effect is insignificant. John Crane can advise on this if required.**

**ATTENTION** The maximum allowable compressor pressure decompression rate is dependent on the process gas and the material of the O-rings used within the gas seal. O-rings suffer the risk of explosive decompression damage if subject to excessive decompression rates. Table 1 lists the maximum allowable decompression rate for 90IRHD fluorocopolymer O-ring. These O-rings are defined by the John Crane global material code 9528 on the installation drawing. For all other O-ring materials where the O-ring is subjected to pressure, the maximum decompression rate is <4bar/min (<58psi/min).

**NOTE** When considering the compressor decompression rate, you must also consider the dew point for the gas being sealed. It must be ensured that the decompression rate, is sufficiently slow to prevent cooling (by adiabatic expansion and the Joule Thomson effect) of the sealed gas such that the temperature is always greater by at least 20°C/68°F above the gas dew point for any pressure to zero pressure. Otherwise, there is a risk of the formation of condensation, liquid drop out and possible freezing at the seal faces.

**ATTENTION** Washing/cleaning compressors  
It is the practice of some compressor operators to “wash” or clean their machines internally whilst in service. John Crane can not recommend that such practises are applied in relation to the gas seal due to the danger of loosening contaminant within the compressor and then this becomes lodged in key areas of the gas seal. Where compressor washing is practiced, then the seal should at all times be buffered by a suitable clean gas supply fed inboard between the seal and the machine’s labyrinth.

Corrosive or reactive chemicals must not come into contact with the gas seal. Only gases, liquids and chemicals which have been specified in the contract of gas seal supply should be allowed to come into contact with the gas seals.

Check monthly for oil in the atmospheric vent lines between the separation seal and the gas seal. Drain any oil in these lines, and rectify the cause. If the level of oil is significant, the gas seals need to be checked for contamination.

### Installation, Operation & Maintenance Instructions

#### NOTE

For periods of shut down or if the compressor is stored for a prolonged time, the seal cartridge should be isolated by blanking off all connecting ports.

#### Storage

John Crane’s Gas Seals should always be stored as follows:

- Seals and/or spare components should remain in their original packaging and purpose built transportation case until required. After use, seals should always be returned to their case for further storage.
- Gas seals should always be stored as complete seal cartridge units with the installation plates properly fitted as shown on the installation drawings.
- The seals within their transportation cases should be stored indoors in a clean, dry environment at a temperature between 15 to 25°C/59 to 77°F.
- Care should be taken to position the transportation case such that the top of the case remains in the top position.
- Care should be taken to ensure that excessively heavy items are not placed on top of the transportation case, nor that cases are stacked in an unsafe manner.
- The transportation case that the seals were originally despatched in is suitable for subsequent shipments of fully assembled seals.

#### ATTENTION

If the gas seals are to be stored inside the compressor for long periods, it is necessary to ensure that they do not become contaminated in any way and adequate precautions need to be taken to prevent this.

If the compressor is shipped with the seals in situ, the shaft should be restrained to prevent movement and potential seal damage. All compressor connections should be sealed off, after ensuring that the atmosphere within the machine is dry. Preserving oil should not be allowed to contact the seal.

#### Service life

Gas seal cartridges need routine refurbishment at regular intervals. It is recommended that seals are returned to John Crane for refurbishment during regular scheduled shut downs.

The length of the successful installed service period will vary depending on the seal environment. For applications with intermittent and wet or dirty processes, the service life may be reduced. Seal condition should be assessed in operation by monitoring leakage levels and trends.

In ideal conditions, seals equipped with O-rings have an expected storage and installed service time of up to 10 years combined.

John Crane recommends sending spare seals back for inspection (health check) after storage, prior to installation.



# TYPE 28 AT

## GAS SEAL

Installation, Operation & Maintenance Instructions

### Transportation

**ATTENTION** It is essential that the gas seals are suitably packaged and always transported in the purpose built transportation case supplied by John Crane.

The gas seals should be assembled as a cartridge unit with the installation plates fitted (preventing movement between the seal rotor and stator).

Any "loose" items placed inside the transportation case must be securely wrapped to prevent transit damage.

For shipments over 16kg: To ensure safe handling, all items exceeding this weight threshold must be secured on pallets in addition to using the purpose-built transportation case.

For other shipping procedures see Appendix II.

**TABLE 1. MAXIMUM DECOMPRESSION RATE FOR O-RINGS**

Pressure of gas being sealed		Compressor maximum temperature – expected to be discharge temperature							
(barg)	(psig)	<20°C bar/min	<68°F psi/min	<75°C bar/min	<167°F psi/min	<130°C bar/min	<266°F psi/min	<80°C bar/min	<356°F psi/min
<82	<1189	No Limit	No Limit	20	290	20	290	20	290
82 to <103.5	1189 to <1501	20	290	20	290	20	290	8	116
103.5 to <124	1501 to <1798	20	290	20	290	8	116	8	116
=>124	=>1798	8	116	8	116	8	116	4	58



### APPENDIX I. Principle of operation

Simply explained, the gas seal typically comprises of a secondary sealed primary ring, located in a static retainer, spring loaded against a rotating mating ring mounted in the seal rotor and fixed to the compressor shaft, as shown in Figure I.a below.

FIGURE I.a

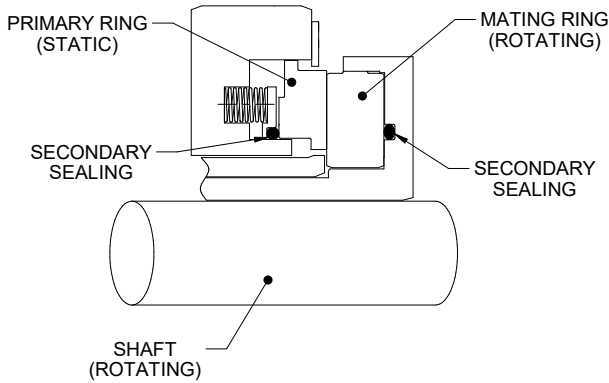

Sealing of the fluid is achieved at the radial interface of the rotating and stationary rings by a unique and ingenious method. The sealing surfaces are lapped to a high degree of flatness, but the rotating mating ring has a series of logarithmic spiral groove patterns printed onto the running face (see Figure I.b).

FIGURE I.b

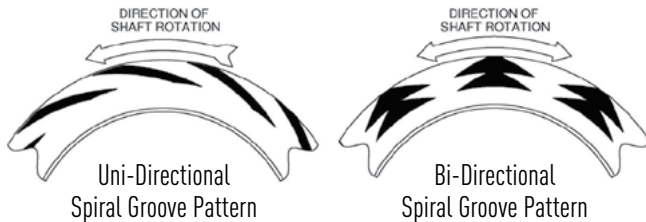

With shaft rotation, gas is drawn inwards towards the root of the groove, called the sealing dam. The sealing dam provides resistance to flow, increasing the pressure. The generated pressure lifts the primary ring out of contact with the mating ring by a small amount typically between  $1\mu\text{m}$  to  $10\mu\text{m}$  ( $39\mu\text{inch}$  to  $390\mu\text{inch}$ ). The gap between the radial faces is set when the closing forces, hydrostatic pressure and spring load, equate to the opening forces generated within the fluid film. It is this very thin sealing gap that allows very high speeds to be accommodated, yet provides sufficient restriction to limit gas flow to acceptable limits of leakage. The gas seal film stiffness is very high providing robust performance and allowing very high pressures to be sealed.

Under equilibrium and a normal operating gap, opening forces = closing forces as illustrated in Figure I.c.

FIGURE I.c

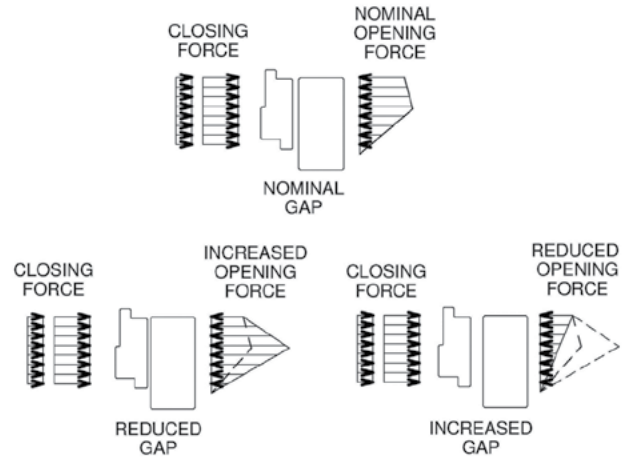

If a disturbance occurs that results in a reduced sealing gap, then the pressure generated by the spiral grooves considerably increases and exceeds the closing force. This will very quickly result in the sealing gap increasing until equilibrium i.e., opening force = closing force and the normal operating gap is restored.

Similarly if an upset causes the gap to increase, there is a reduction in the pressure generated by the spiral groove resulting in closing force being greater than opening force. This will result in the sealing gap closing until equilibrium and a normal sealing gap is again restored.

The result of this mechanism is a highly stable yet thin fluid interface between the static primary ring and the rotating mating ring that keeps the two sealing surfaces apart under normal dynamic operating conditions. In turn this leads to a reliable seal with long life as there is no wear at the interface.

To achieve this John Crane has invested heavily in advanced technologies and has built up a considerable and unsurpassed fund of knowledge and experience in rotary shaft gas sealing applications.

There are many principles governing the seal's performance only a few of which are explained in the previous paragraphs. Further information is available from John Crane.

### APPENDIX II. Returning seals to John Crane

All gas seals should be returned to John Crane for any refurbishment. Prior to refurbishment, customers must confirm in writing that the specific seals being returned are safe to handle and provide any additional safety-critical information on request. John Crane can provide a suitable form for this purpose.

The following information must be made available on the shipping documentation.

1. Installation drawing numbers
2. Cartridge numbers
3. Value (for insurance only)
4. Commodity code 84842000000

For refurbishment, contact your local John Crane sales representative for shipping details of your nearest John Crane Turbomachinery Service Center.

### APPENDIX III. Replacing tolerance rings

On certain gas seal designs, tolerance rings are located within the sleeve bore of the gas seal (see Figure 1). The function of these tolerance rings is to centralize the seal rotor on the compressor shaft. The tolerance ring fits into a groove machined into the bore of the sleeve and is glued in place. If the tolerance rings have become damaged and crushed during service they can be replaced as per the instructions below, though this may adversely affect the seal balance.

**ATTENTION** It is essential the tolerance ring is fully located in the appropriate groove. If excessive glue is used, it can result in shaft damage.



**Exercise extreme care when handling tolerance ring as the edges can be sharp. Wear appropriate gloves throughout the fitting process.**

The method of installing a tolerance ring is as follows:

1. Spare tolerance ring will be supplied within the gas seal spares kit. This will be secured in place with a two part quick acting adhesive such as Loctite Multi Bond (not supplied by John Crane).
2. For the tolerance ring already fitted to the seal, observe that the dimples of the tolerance ring are in the direction of the compressor shaft. Also notice where the gap in the tolerance ring is. This gap will align with the "T" balance mark on the outside of the sleeve rotor.

**NOTE** On certain designs where the seal rotor is fully obscured by the seal stator, the "T" balance mark will not be visible. When replacing tolerance ring, it should always be installed with the dimples in the correct direction and the gap in the same location as originally supplied. See Figure III.a.

FIGURE III.a

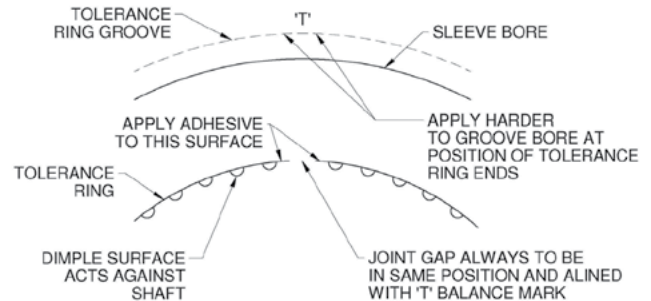

3. For the damaged tolerance ring to be removed, mark the location of the tolerance ring gap with an appropriate pen.
4. Remove the old tolerance ring and all traces of adhesive or weld joint debris from the groove in the sleeve bore.
5. Using a small pair of tin-snips, carefully cut a new tolerance ring between "waves" to slightly longer length than required.
6. With the dimples of the ring on the inside of curve (see point 2) above), curl the tolerance ring to the best possible fit of the groove.
7. Trim the tolerance ring length such that a 5mm/0.200" gap is established between the ends of the tolerance ring when fitted into the groove. Cut the chamfered profile as shown in Figure III.b on both ends.

FIGURE III.b

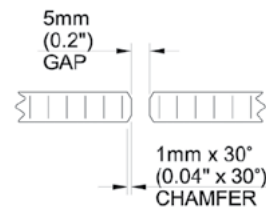

8. Clean the tolerance ring and the sleeve bore grooves with a suitable solvent.
9. The tolerance ring is held in place by a two part quick acting adhesive such as Loctite Multi Bond. Apply adhesive sparingly to 3 waves only at one end, of the replacement tolerance ring.
10. Ensuring the tolerance ring gap is in the correct position; apply hardener to the sleeve groove over a similar length.
11. Locate the tolerance ring within its groove. Apply thumb pressure to the tolerance ring in the region of the adhesive, until the adhesive has set.
12. Repeat steps 9, 10 and 11 for the other end of the replacement tolerance ring ensuring that the ring is pushed fully back around the circumference of the groove.
13. When the adhesive is fully set, remove any excess adhesive from the seal bore that interferes with seal fitting..



# TYPE 28 AT

GAS SEAL

Installation, Operation & Maintenance Instructions



<b>North America</b> United States of America Tel: 1-847-967-2400	<b>Europe</b> United Kingdom Tel: 44-1753-224000	<b>Latin America</b> Brazil Tel: 55-11-3371-2500	<b>Middle East &amp; Africa</b> United Arab Emirates Tel: 971-481-27800	<b>Asia Pacific</b> Singapore Tel: 65-6518-1800
---	--	--	---	---

If the products featured will be used in a potentially dangerous and/or hazardous process, your John Crane representative should be consulted prior to their selection and use. In the interest of continuous development, John Crane Companies reserve the right to alter designs and specifications without prior notice. It is dangerous to smoke while handling products made from PTFE. Old and new PTFE products must not be incinerated. ISO 9001 and ISO14001 Certified, details available on request.